

Installation Guide

# EtherNet/IP Card

VLT® Soft Starter MCD 600





## Contents

<b>1</b>	<b>Safety</b>	<b>6</b>
1.1	Disclaimer	6
1.2	Warnings	6
<b>2</b>	<b>Introduction</b>	<b>7</b>
2.1	Product Design	7
2.2	Compatibility	7
2.3	Network Connection	7
<b>3</b>	<b>Installation</b>	<b>8</b>
3.1	Installing the Expansion Card	8
3.2	Network Connections	8
3.2.1	Ethernet Ports	8
3.2.2	Cables	8
3.2.3	EMC Precautions	8
3.3	Network Establishment	8
3.4	Addressing	8
<b>4</b>	<b>Device Configuration</b>	<b>9</b>
4.1	Before Configuring the Device	9
4.2	Configuration Methods	9
4.3	Parameters for Configuring Network Settings	9
4.4	Enabling Network Control	9
4.5	On-board Web Server	10
4.5.1	Connect to the Device	10
4.5.2	Manage Users and Passwords	11
4.5.2.1	Adding a User	11
4.5.2.2	Deleting a User	11
4.5.3	Configuring the IP Address	12
4.5.4	Configure IoT Settings	12
4.5.4.1	Configuring MQTT Settings	13
4.5.4.2	Configuring OPC UA Settings	14
4.6	Scanning the Network	14
4.6.1	Identifying the Device with Ethernet Device Configuration Tool	14
<b>5</b>	<b>Scanner Configuration</b>	<b>16</b>
5.1	EDS File	16
5.2	Assembly Objects	16

<b>6</b>	<b>Operation</b>	<b>17</b>
6.1	Requirements for Successful Operation	17
6.2	Device Classification	17
6.3	Ensuring Safe and Successful Control	17
6.4	Feedback LEDs	17
<b>7</b>	<b>Messaging</b>	<b>18</b>
7.1	Implicit Messaging (Cyclic Operation)	18
7.1.1	Assembly Objects	16
7.1.2	Control Commands (Assembly Instance 104d)	18
7.1.2.1	Bytes 0–1: Command	18
7.1.2.2	Bytes 2–3: Reserved	18
7.1.2.3	Command Examples	18
7.1.3	Status Information (Assembly Instance 154d)	19
7.1.3.1	Bytes 0–1: Starter State	19
7.1.3.2	Bytes 2–3: Reserved	19
7.1.3.3	Bytes 4–7: Motor Current	19
7.1.3.4	Bytes 8–9: Trip Code	20
7.1.3.5	Bytes 10–11: Reserved	20
7.2	Explicit Messaging (Acyclic Operation)	20
7.2.1	Identity Object (Class 0x01)	20
7.2.2	Vendor-specific Objects	20
7.2.2.1	Class 100 and 101 Objects (Read/Write)	20
7.2.2.2	Class 103 Objects (Read Only)	20
7.2.2.3	Class 104 Objects (Read Only)	22
7.2.3	Supported Services for Vendor-specific Objects	22
7.2.3.1	Service Codes for Acyclic Operation	23
7.2.3.2	Status Codes for Acyclic Services	23
<b>8</b>	<b>Attributes</b>	<b>24</b>
8.1	Trip Codes	24
8.2	Parameter Lists	25
8.2.1	Parameters, Class 100 and Class 101 Objects (Read/Write)	26
<b>9</b>	<b>Network Design</b>	<b>30</b>
9.1	Star Topology	30
9.2	Line Topology	30
9.3	Ring Topology	31
9.4	Combined Topologies	31



---

<b>10 Specifications</b>	<b>33</b>
10.1 Connections	33
10.2 Settings	33
10.3 Network	33
10.4 Power	33
10.5 Certification	33

---

## 1 Safety

### 1.1 Disclaimer

The examples and diagrams in this manual are included solely for illustrative purposes. The information contained in this manual is subject to change at any time and without prior notice. Responsibility or liability is never accepted for direct, indirect, or consequential damage resulting from the use or application of this equipment.

### 1.2 Warnings

#### ⚠ W A R N I N G ⚠

##### SHOCK HAZARD

Attaching or removing accessories while the soft starter is connected to mains voltage may cause personal injury.

- Before attaching or removing accessories, isolate the soft starter from mains voltage.

#### ⚠ W A R N I N G ⚠

##### RISK OF PERSONAL INJURY AND EQUIPMENT DAMAGE

Inserting foreign objects or touching the inside of the soft starter while the expansion port cover is open may endanger personnel and can damage the soft starter.

- Do not insert foreign objects in the soft starter with the port cover open.
- Do not touch the inside of the soft starter with the port cover open.

## 2 Introduction

### 2.1 Product Design

The EtherNet/IP Card allows the soft starter to connect to an Ethernet network and be controlled or monitored using an Ethernet communication model.

Familiarity with Ethernet protocols and networks is required to operate the device successfully. For difficulties arising from using this device with 3<sup>rd</sup>-party products, including PLCs, scanners, and commissioning tools, contact the relevant supplier.

### 2.2 Compatibility

This communication expansion card is suitable for use with VLT® Soft Starter MCD 600.

This Installation Guide is intended for use with version 2.x of the VLT® Soft Starter MCD 600 EtherNet/IP Card. Version 1.x of the EtherNet/IP Card does not support custom users, TCP connection, or IoT operation.

### 2.3 Network Connection

Table 1: Supported Protocols

Protocols	
EtherNet/IP	Industrial Ethernet via EtherNet/IP
TCP	Transmission control protocol to connect to port 4000 of a PC
MQTT	Message queue telemetry transport
OPC UA	Open platform communications unified architecture

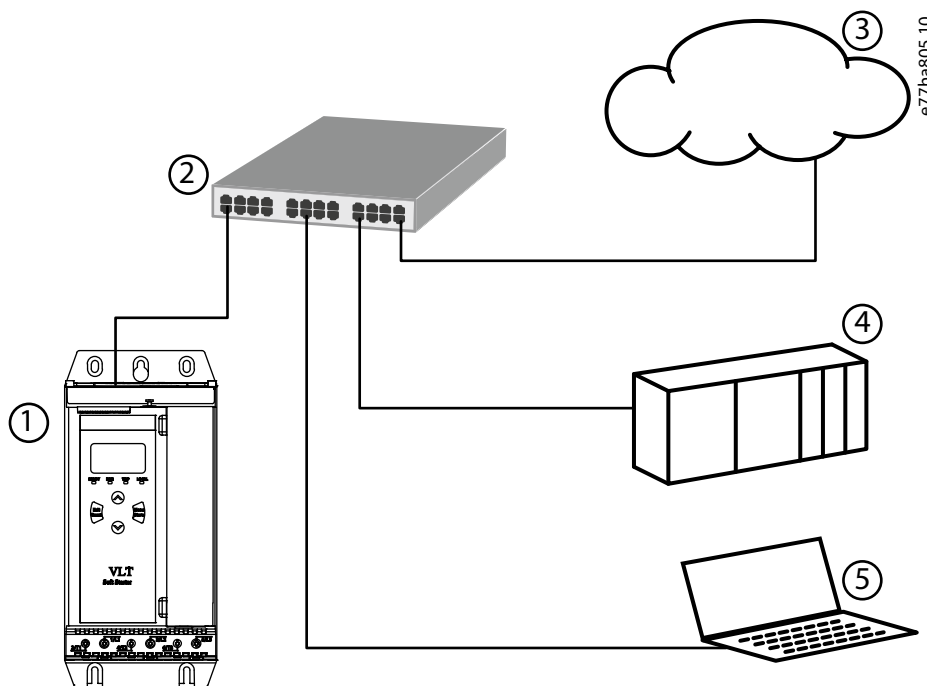
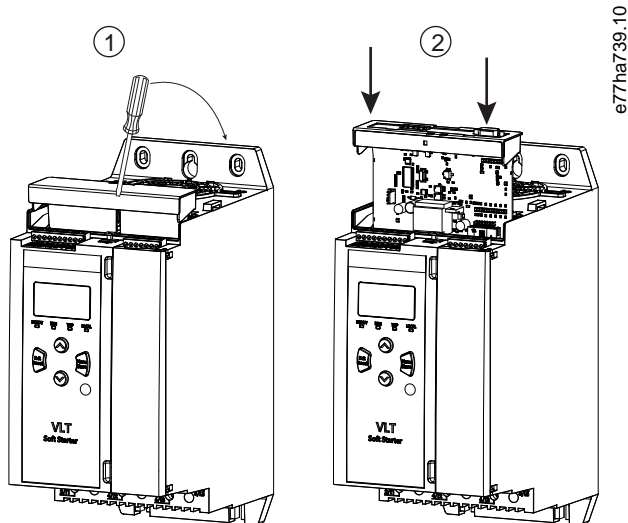

Illustration 1: Overview of Network Connections

1	Soft starter	4	Industrial Ethernet connection to programmable logic controller
2	Network switch	5	TCP connection to VLT® Motion Control Tool MCT 10. Refer to the VLT® Motion Control Tool MCT 10 Operating Guide for connection details.
3	IoT connection (MQTT/OPC UA)		

## 3 Installation

### 3.1 Installing the Expansion Card



#### Procedure

1. Push a small flat-bladed screwdriver into the slot in the center of the expansion port cover and ease the cover away from the soft starter.
2. Align the card with the expansion port. Gently push the card along the guide rails until it clicks into the soft starter.

### 3.2 Network Connections

#### 3.2.1 Ethernet Ports

The device has 2 Ethernet ports. If only 1 connection is required, either port can be used.

#### 3.2.2 Cables

When connecting to the device, make sure that the cables are of 1 of the following categories:

- Category 5
- Category 5e
- Category 6
- Category 6e

#### 3.2.3 EMC Precautions

To minimize electromagnetic interference, Ethernet cables should be separated from motor and mains cables by 200 mm (7.9 in). If the Ethernet cable must cross motor or mains cables, the crossing should be at an angle of 90°.

### 3.3 Network Establishment

The controller must establish communications directly with each device before the device can participate in the network.

### 3.4 Addressing

Each device in a network is addressed using a MAC address and an IP address.

- The device can be assigned a static IP address during configuration or can be configured to accept a dynamic IP address (via DHCP).
- The MAC address is fixed within the device and is printed on a label on the front of the device.



## 4 Device Configuration

### 4.1 Before Configuring the Device

#### NOTICE

The error LED flashes whenever the device is receiving power but is not connected to a network. The error LED will flash occasionally during the configuration process.

#### NOTICE

At power-up, the communication card loads the IP address stored in the soft starter.

### 4.2 Configuration Methods

Network communication parameters for the communication card can be set via the soft starter or via the on-board web server.

- The card uses a static IP address by default. To enable DHCP addressing, set *parameter 12-20 DHCP* to enable or change the setting via the on-board web server.
- The IP address can be set via the programmable parameters of the soft starter.
- The web server can configure the IP address and messaging settings for MQTT/OPC UA operation.

### 4.3 Parameters for Configuring Network Settings

Use *parameters 12-8 to 12-21* to configure the network address. The parameters can be set via the Main Menu, via the Setup Tools, or by uploading a configuration file via USB Save & Load.

Parameter	Default
12-8 Gateway Address	192
12-9 Gateway Address 2	168
12-10 Gateway Address 3	0
12-11 Gateway Address 4	100
12-12 IP Address	192
12-13 IP Address 2	168
12-14 IP Address 3	0
12-15 IP Address 4	2
12-16 Subnet Mask	255
12-17 Subnet Mask 2	255
12-18 Subnet Mask 3	255
12-19 Subnet Mask 4	0
12-20 DHCP	Disable
12-21 Location ID	0

### 4.4 Enabling Network Control

#### NOTICE

If the reset input is active, the soft starter does not operate. If a reset switch is not required, use *parameter 7-9* to set the reset input to normally open or fit a link across terminals RESET, COM+ on the soft starter.

Procedure

1. Set *parameter 1-1 Command Source* to Network for the soft starter to accept commands from the EtherNet/IP Card.

### 4.5 On-board Web Server

#### 4.5.1 Connect to the Device

To configure settings using the on-board web server, the EtherNet/IP Card must be installed in a soft starter, control power must be available, and the card and computer must both be connected to the Ethernet network.

The computer must use a fixed IP address (not DHCP) and the same subnet mask as the card. The default IP address for the card is 192.168.0.2. The default subnet mask is 255.255.255.0.

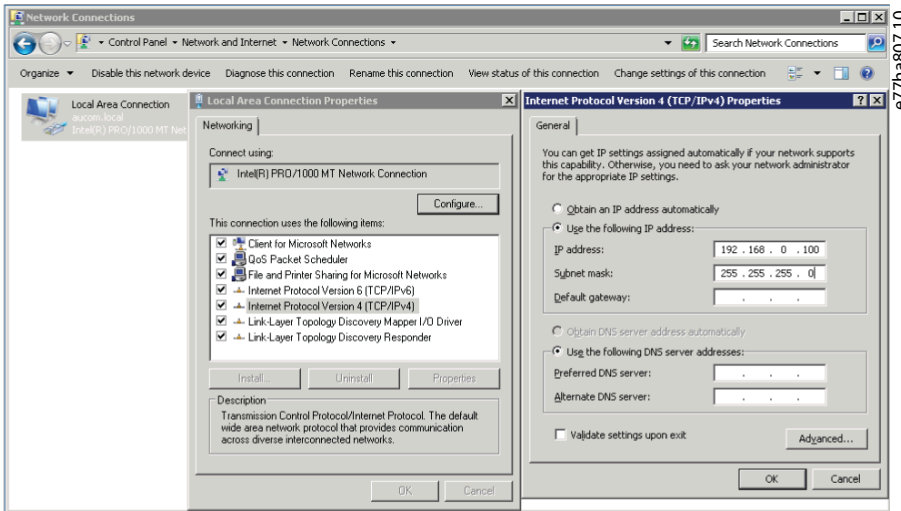

Once connected, the web server reports basic information about the card and the soft starter.

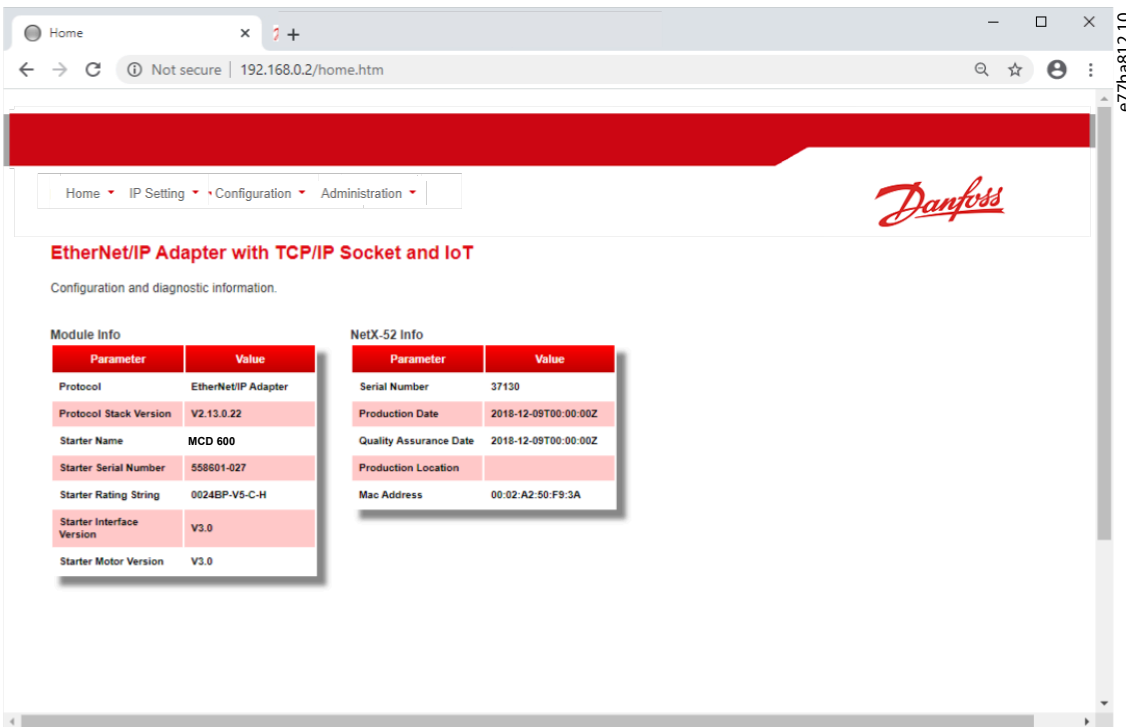

## 4.5.2 Manage Users and Passwords

### NOTICE

For security reasons, define a custom administrator ID and password. The default username and password are:

- Username: danfoss\_admin
- Password: danfoss\_admin

### NOTICE

Version 1.x of the EtherNet/IP Card does not support custom users.

The EtherNet/IP Card supports multiple users and levels of privilege.

- Users can view the home screen and IP settings.
- Supervisors can view the home screen and IP settings, and they can change configuration settings.
- Administrators can view the home screen, change configuration settings, and add or delete users.

### 4.5.2.1 Adding a User

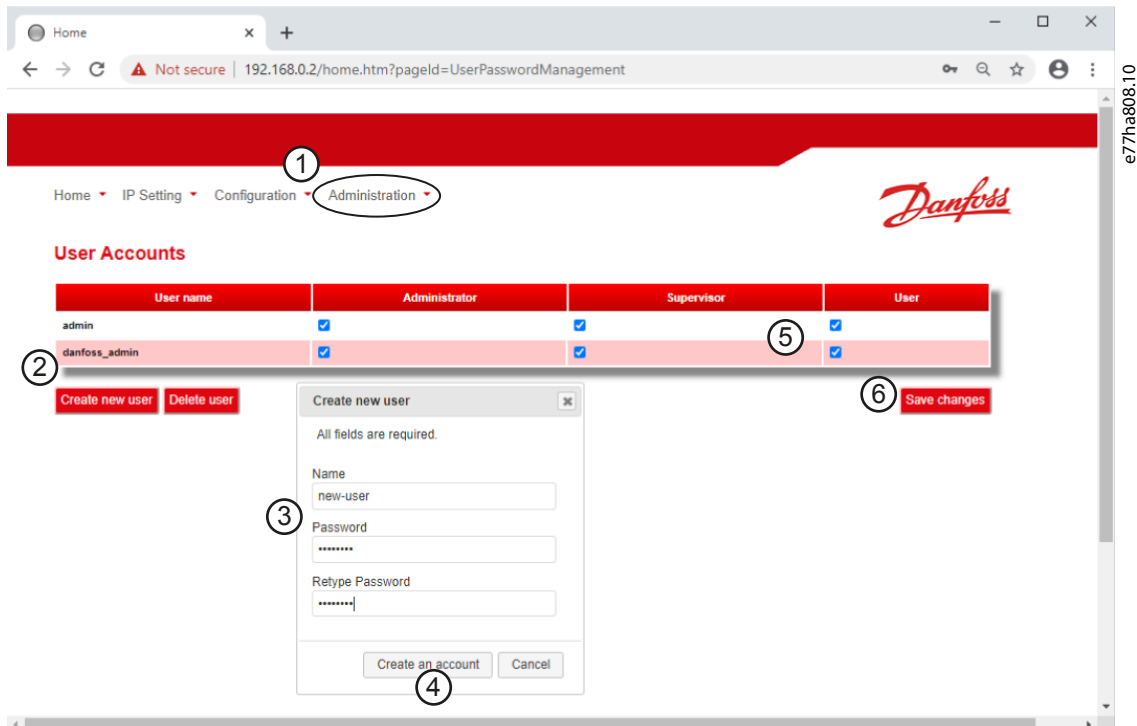

The screenshot shows a web browser window at 192.168.0.2/home.htm?pagelId=UserPasswordManagement. The interface has a red header with the Danfoss logo and a navigation menu. The 'Administration' menu item is circled with a '1'. Below the menu is a 'User Accounts' table with columns for 'User name', 'Administrator', 'Supervisor', and 'User'. The 'danfoss\_admin' row is highlighted, and its 'Administrator' and 'Supervisor' checkboxes are circled with a '5'. A 'Create new user' dialog box is open, showing fields for 'Name' (containing 'new-user'), 'Password', and 'Retype Password'. The 'Create an account' button is circled with a '4'. A 'Save changes' button is circled with a '6'. The 'Create new user' button in the table is circled with a '2'.

#### Procedure

1. Connect to the web server and click *Administration*.
2. Click *Create new user*.
3. Enter the new username and password.
4. Click *Create an account*.
5. Set privileges (user, supervisor, administrator) as appropriate.
6. Click *Save changes*.

### 4.5.2.2 Deleting a User

#### Procedure

1. Connect to the web server and click *Administration*.
2. Select the required entry in the user list and click *Delete*.
3. Click *Delete* again to confirm the action.

### 4.5.3 Configuring the IP Address

#### NOTICE

For version 1.x of the EtherNet/IP Card, changes made via the web server are not stored in the soft starter and will be lost when control power is cycled.

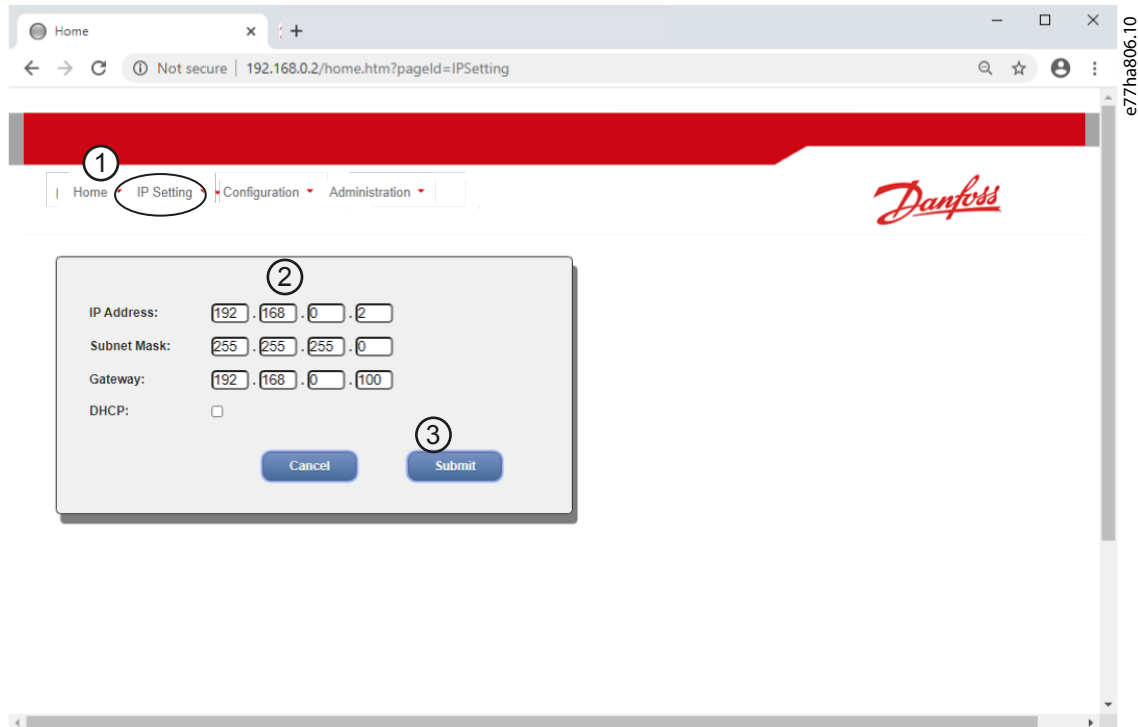

#### Procedure

1. Connect to the web server and click *IP Setting*.
2. Edit settings as required. To enable DHCP addressing, tick the DHCP checkbox.
3. Click *Submit* to send the new settings to the device.

### 4.5.4 Configure IoT Settings

The EtherNet/IP Card supports soft starter status monitoring via IoT. The card cannot control or program the soft starter.

#### NOTICE

Version 1.x of the EtherNet/IP Card does not support IoT operation.



### 4.5.4.1 Configuring MQTT Settings

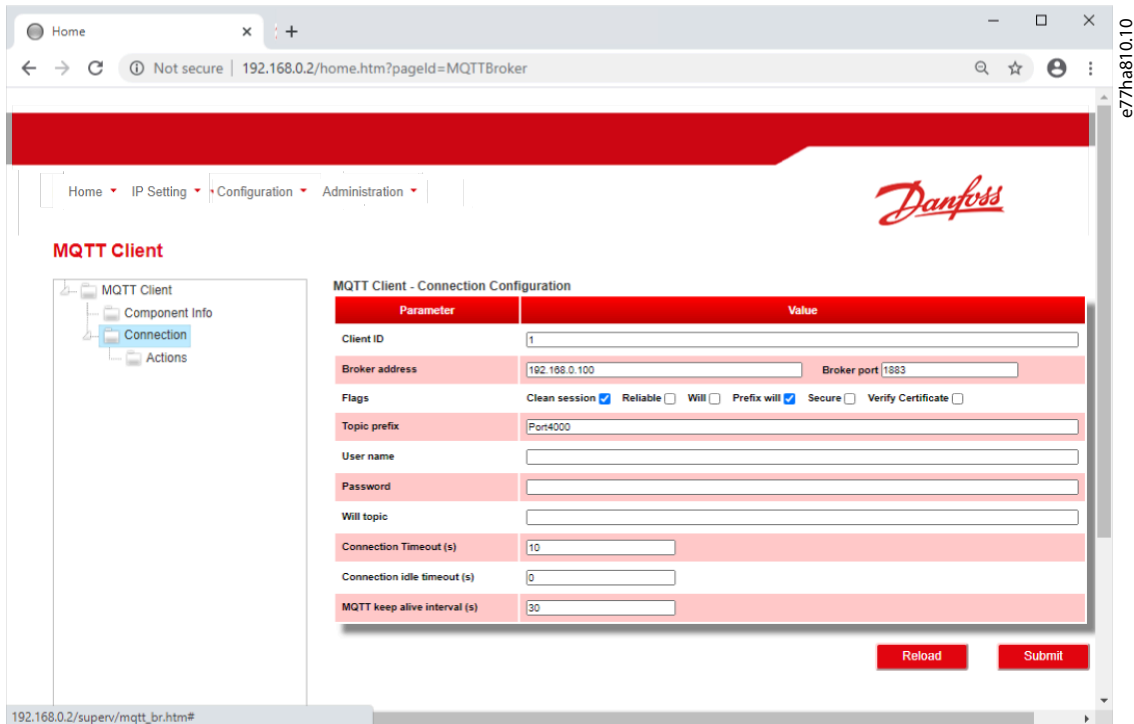

#### Procedure

1. Connect to the web server and click *Configuration*.
2. Select *MQTT Client*.
3. Tick the *Enable* checkbox to enable MQTT client operation.

The MQTT client is enabled by default.

4. Click *Connection* and configure the settings as required.
5. Click *Connections* ⇒ *Actions* to select which information the card should publish.
6. Click *Submit* to save all settings in the card.

### 4.5.4.2 Configuring OPC UA Settings

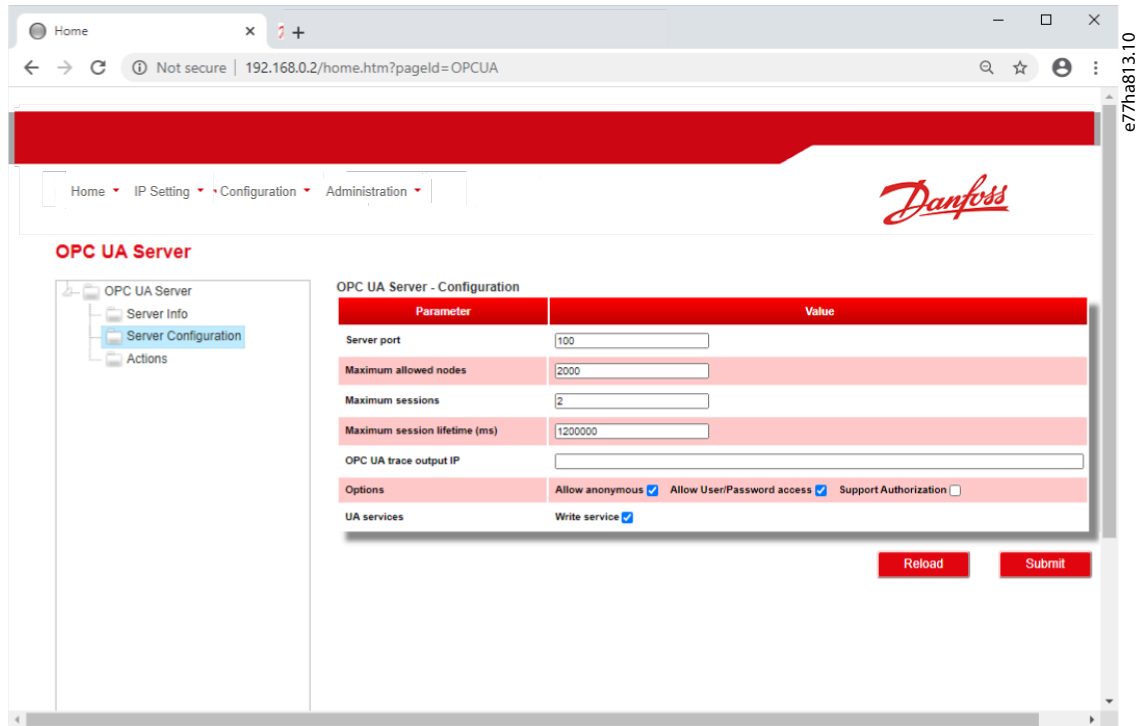

#### Procedure

1. Connect to the web server and click *Configuration*.
2. Select *OPC UA Server*.
3. Tick the *Enable* checkbox to enable OPC UA client operation.

The OPC UA client is enabled by default.

4. Click *Server Configuration* and configure the settings as required.
5. Select *Actions* to select the actions for different object instances.
6. Click *Submit* to save all settings in the card.

### 4.6 Scanning the Network

If there is no connection to the web server and the soft starter cannot be accessed physically, use the Ethernet Device Configuration Tool to scan the network and identify the device. Changes made via the Ethernet Device Configuration Tool cannot be stored permanently in the device and will be lost when the control power is cycled.

Download the Ethernet Device Configuration Tool from [www.danfoss.com](http://www.danfoss.com) under the sections Services/PC-tools.

## NOTICE

If the PC has a firewall enabled, add the tool to the list of authorized programs.

#### 4.6.1 Identifying the Device with Ethernet Device Configuration Tool

##### Procedure

1. Start the Ethernet Device Configuration Tool.
2. Click *Search Devices*.

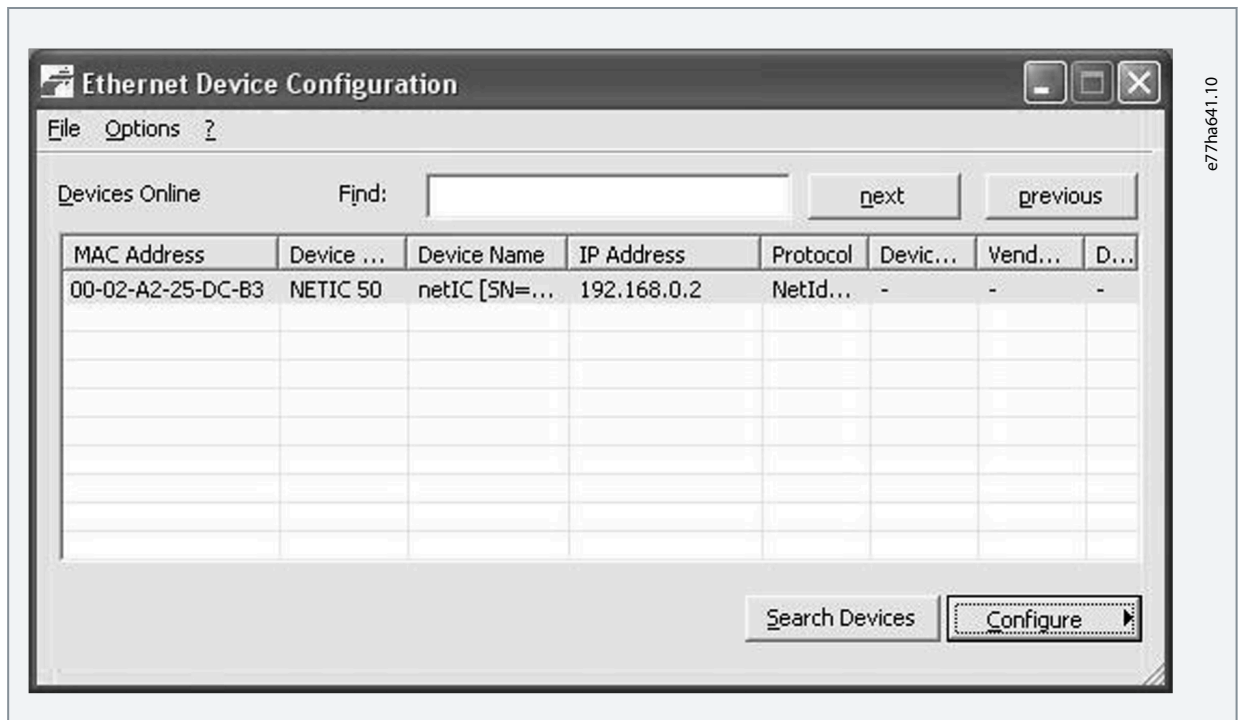

↶ The software searches for connected devices.

3. Use the IP address to connect to the device via the web server.

## 5 Scanner Configuration

### 5.1 EDS File

An EDS file containing all required attributes of the device is available from the supplier. Once the EDS file has been located, the individual device must be defined.

### 5.2 Assembly Objects

Table 2: Supported Assembly Objects

Description	Class	Instance	Type	Maximum size
Output (scanner⇒soft starter)	04d (0x04)	104d (0x68)	Integer	2 (4 bytes)
Input (soft starter⇒scanner)	04d (0x04)	154d (0x9A)	Integer	6 (12 bytes)



## 6 Operation

### 6.1 Requirements for Successful Operation

The EtherNet/IP Card is conformance tested to ODVA. For successful operation, the scanner must also support all functions and interfaces described in this manual.

#### NOTICE

The available features and parameter details may vary according to the model and software version of the soft starter. Refer to the VLT® Soft Starter MCD 600 Operating Guide for details of parameters and supported features.

### 6.2 Device Classification

The EtherNet/IP Card is an I/O adapter and must be managed by an I/O scanner over Ethernet.

The EtherNet/IP Card supports both implicit (cyclic) and explicit (acyclic) messaging.

### 6.3 Ensuring Safe and Successful Control

Data written to the device remains in its registers until the data is overwritten or the device is reinitialized. If the soft starter is controlled via *parameter 7-1 Command Override* or is disabled via the reset input (terminals RESET, COM+), fieldbus commands should be cleared from the registers. If a command is not cleared, it is re-sent to the soft starter once fieldbus control resumes.

### 6.4 Feedback LEDs

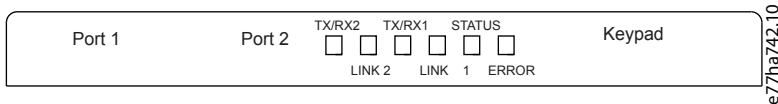

Table 3: LED Descriptions

LED name	LED state	Description
Error	Off	The device is not powered up or has received an IP address.
	Flashing	Connection timeout.
	On	Duplicate IP address.
Status	Off	The device is not powered up or has received an IP address.
	Flashing	The device has obtained an IP address but has not established any network connections.
	On	Communication has been established.
Link x	Off	No network connection.
	On	Connected to a network.
TX/RX x	Flashing	Transmitting or receiving data.

## 7 Messaging

### 7.1 Implicit Messaging (Cyclic Operation)

This section lists the requirements related to cyclic (implicit messaging) services for the EtherNet/IP Card. The minimum cyclic interval is 1 ms. All data is in little endian format.

#### 7.1.1 Assembly Objects

Table 4: Supported Assembly Objects

Description	Class	Instance	Type	Maximum size
Output (scanner⇒soft starter)	04d (0x04)	104d (0x68)	Integer	2 (4 bytes)
Input (soft starter⇒scanner)	04d (0x04)	154d (0x9A)	Integer	6 (12 bytes)

#### 7.1.2 Control Commands (Assembly Instance 104d)

To send control data from the scanner to the soft starter, use assembly class 04d (0x04), assembly instance 104d (0x68), attribute 03d (0x03).

##### 7.1.2.1 Bytes 0–1: Command

Bits	Function	Details
0–5	Reserved	Must be 0.
6	Run	0 = Stop command 1 = Start command
7	Reset	Changing this bit from 0 to 1 resets a trip.
8–12	Reserved	Must be 0.
13	Motor set select	0 = Use primary motor set when starting. 1 = Use secondary motor set when starting.
14–15	Reserved	Must be 0.

##### 7.1.2.2 Bytes 2–3: Reserved

Bits	Function	Details
0–15	Reserved	Must be 0.

##### 7.1.2.3 Command Examples

Byte	Value	Description
0	0b01000000 (64d, 0x40)	Command: Start the soft starter.
1	0b00000000 (00d, 0x00) or 0b00100000 (32d, 0x20)	Command: Select primary or secondary motor settings when starting.
0	0b10000000 (128d, 0x80)	Command: Reset the soft starter. The reset only occurs when the previous reset bit is 0, otherwise the value of 1 is ignored.
0	0b11000000 (192d, 0xC0)	Command: Reset and start the soft starter.
0	0bX0000000 (00d, 0x00)	Command: Stop the soft starter.

### 7.1.3 Status Information (Assembly Instance 154d)

To retrieve status data from the soft starter, use assembly class 04d (0x04), assembly instance 154d (0x9A), attribute 03d (0x03).

#### 7.1.3.1 Bytes 0–1: Starter State

Bits	Function	Details
0	Ready	0 = Not ready 1 = Ready to start
1	Operating mode	0 = Program mode 1 = Operating mode
2	Running	0 = Not ready, ready to start, or tripped 1 = Starting, Running, Stopping, or Jogging
3	Trip	0 = Not tripped 1 = Tripped
4	Jog forward	1 = Jog forward
5	Jog reverse	1 = Jog reverse
6	Reserved	
7	Warning	0 = No warning 1 = Warning
8	Ramping	1 = Running (full voltage at the motor)
9	Command source	0 = Remote LCP, digital input, clock 1 = Network
10	Reserved	
11	Reserved	
12	Reserved	
13	Reserved	
14	Reserved	
15	Temperature limit	0 = Motor operating within thermal capacity (thermal model) 1 = Motor operating above thermal capacity (thermal model)

#### 7.1.3.2 Bytes 2–3: Reserved

Bits	Function	Details
0–15	Reserved	

#### 7.1.3.3 Bytes 4–7: Motor Current

Bits	Function	Details
0–31	Motor current	Average rms current across all 3 phases. Measured current is shown as a 32-bit value to 2 decimal places. 10d (0x0A) = 0.10 A 3450d (0xD7A) = 34.50 A

Bits	Function	Details
		68930d (0x10D42) = 689.30 A

### 7.1.3.4 Bytes 8–9: Trip Code

Bits	Function	Details
0–15	Trip code	See the chapter <i>Trip Codes</i> .

### 7.1.3.5 Bytes 10–11: Reserved

Bits	Function	Details
0–15	Reserved	

## 7.2 Explicit Messaging (Acyclic Operation)

This section provides information on objects, instances, attributes, and services for acyclic operation (explicit messaging). All data is in little endian format.

### 7.2.1 Identity Object (Class 0x01)

Table 5: Supported Attributes for Identity Objects

Attribute	Function	Value
1	Vendor	204d (0xCC)
2	Device type	12d (0x0C)
3	Product code	269d (0x10D)
4	Revision: Major, minor	EDS file version
5	Status	Supported
6	Serial number	Supported
7	Product name	Supported

### 7.2.2 Vendor-specific Objects

The EtherNet/IP Card supports vendor-specific classes 100, 101, 103, and 104.

#### 7.2.2.1 Class 100 and 101 Objects (Read/Write)

Class 100 and 101 objects allow parameter values to be read from and written to the soft starter.

- Class 100d (0x64): Parameters 1–99
- Class 101d (0x65): Parameters 100–199

See the chapter *Parameter Lists* for more details.

#### 7.2.2.2 Class 103 Objects (Read Only)

Class 103d (0x67) allows soft starter state information to be read from the soft starter.

## N O T I C E

For models MCD6-0063B and smaller, current reported via communications is 10 times greater than the actual value shown on the LCP.



Table 6: Objects to be Read from the Soft Starter

Object name	Class	Instance	Attribute
Binary protocol version	103	100	100
Product type code	103	101	100
Reserved	103	102	100
Reserved	103	103	100
Soft starter model	103	104	100
Changed parameter number	103	105	100
Number of parameters	103	106	100
Changed parameter value	103	107	100
Reserved	103	108	100
Soft starter state 1 = Ready 2 = Starting 3 = Running 4 = Stopping (including braking) 5 = Restart delay (including temperature check) 6 = Tripped 7 = Programming mode 8 = Jog forward 9 = Jog reverse	103	109	100
Warning 0 = No warning 1 = Warning	103	110	100
Initialized 1 = Phase sequence is valid	103	111	100
Phase sequence (1 = Positive phase sequence, only valid if Initialized = 1)	103	112	100
Reserved	103	113	100
Reserved	103	114	100
Trip/Warning code (see chapter <i>Trip Codes</i> )	103	115	100
Average rms current across all 3 phases	103	116	100
Current (% motor FLC)	103	117	100
Motor temperature	103	118	100
Reserved	103	119	100
Power	103	120	100
Power scale 0 = Multiply power by 10 to get W	103	121	100

Object name	Class	Instance	Attribute
1 = Multiply power by 100 to get W 2 = Power (kW) 3 = Multiply power by 10 to get kW			
% Power factor	103	122	100
Average rms voltage across all 3 phases	103	123	100
Phase 1 current	103	124	100
Phase 2 current	103	125	100
Phase 3 current	103	126	100
Phase 1 voltage	103	127	100
Phase 2 voltage	103	128	100
Phase 3 voltage	103	129	100
Parameter list minor version	103	130	100
Parameter list major version	103	131	100
Digital input state For all inputs, 0 = open, 1 = closed (short-circuited) Start/stop input = 01h, reset = 04h, programmable input A = 08h, programmable input B = 10h	103	132	100

## N O T I C E

The reset input is normally closed by default. If *parameter 7-9 Reset/Enable Logic* is set to normally open, the reported state is inverted (0 = closed, 1 = open).

### 7.2.2.3 Class 104 Objects (Read Only)

Class 104d (0x68) allows extended information to be read from the soft starter.

Object name	Class	Instance	Attribute
Major software version - User interface	104	101	100
Minor software version - User interface	104	102	100
Major software version - Motor control	104	103	100
Minor software version - Motor control	104	104	100
Major software version - Remote LCP (if installed)	104	105	100
Minor software version - Remote LCP (if installed)	104	106	100
Major software version - Expansion card (if installed)	104	107	100
Minor software version -. Expansion card (if installed)	104	108	100

### 7.2.3 Supported Services for Vendor-specific Objects

This section describes the operational instructions to carry out acyclic services on class objects 100, 101, 103, and 104.

### 7.2.3.1 Service Codes for Acyclic Operation

Table 7: Supported Services for Vendor-specific Objects

Service code	Function	Description
01d (0x01)	Get attribute all	Only supported for class 0x01 identity object
10d (0x10)	Set attribute single	Supported
15d (0x0E)	Get attribute single	Supported

### 7.2.3.2 Status Codes for Acyclic Services

Table 8: Status Codes Returned in Response to Get/Set Attribute Single

Status code	Status name	Details
00d (0x00)	Success	This code is returned when: <ul style="list-style-type: none"> <li>the register mapped for Get Attribute Single is successfully read.</li> <li>the register mapped for "Set Attribute Single" is successfully set.</li> </ul>
03d (0x03)	Invalid parameter value	–
05d (0x05)	Path destination unknown	The mapped register does not exist.
08d (0x08)	Service not supported	The requested service is not available for this object class/instance.
09d (0x09)	Invalid attribute value	This code only applies to the service Set Attribute Single. It is returned if the value is out of range of the mapped register.
15d (0x0E)	Attribute not settable	This code only applies to the service Set Attribute Single. It is returned if the mapped register is read-only.
20d (0x14)	Attribute not supported	The attribute specified in the request is not supported.
22d (0x16)	Object does not exist	The object specified does not exist in the device.

## 8 Attributes

### 8.1 Trip Codes

Code	Description
0	No trip
11	Input A trip
20	Motor overload
21	Heatsink overtemperature
23	L1 phase loss
24	L2 phase loss
25	L3 phase loss
26	Current imbalance
28	Overcurrent
29	Undercurrent
50	Power loss
51	Undervoltage
52	Overvoltage
54	Phase sequence
55	Frequency
60	Incorrect control card
61	FLC out of range
62	EEPROM fail (parameter out of range)
75	Motor thermistor
101	Excess start time
102	Motor connection
104	Internal fault
110	Input B trip
113	Communications card fault
114	Network communication
115	L1-T1 shorted
116	L2-T2 shorted
117	L3-T3 shorted
119	Bypass overload
120	SCR overtemperature

Code	Description
121	Battery/clock
122	Thermistor circuit
124	RTD/PT100 B
133	Overpower
134	Underpower
142	LCP disconnected
143	Zero speed detect
144	SCR Itsm
145	Instantaneous overcurrent
146	Rating capacity
156	Current read error L1
157	Current read error L2
158	Current read error L3
160	Motor connection T1
161	Motor connection T2
162	Motor connection T3
163	Firing fail P1
164	Firing fail P2
165	Firing fail P3
166	VZC fail P1
167	VZC fail P2
168	VZC fail P3
169	Low control volts
170–182	Internal fault X. Contact the local supplier with the fault code (X).

## 8.2 Parameter Lists

### NOTICE

These parameter lists are for parameter list version 2.x. To check the parameter list version, read class 103d, instance 131, attribute 100.

For other parameter list versions, refer to the soft starter Operating Guide or contact the local supplier for assistance.

### NOTICE

The numbering of parameter options via communications starts at 0. For Phase Sequence, 0 = Any sequence, 1 = Positive only, 2 = Negative only.

## 8.2.1 Parameters, Class 100 and Class 101 Objects (Read/Write)

Table 9: Objects with Class, Instance, and Attribute

Object name	Class	Instance	Attribute	Object name	Class	Instance	Attribute
<b>Class 100 objects</b>				Motor kW-2	100	127	100
<b>Motor details</b>				Start Mode-2	100	128	100
Command Source	100	101	100	Start Ramp Time-2	100	129	100
Motor Full Load Current	100	102	100	Initial Current-2	100	130	100
Motor kW	100	103	100	Current Limit-2	100	131	100
Locked Rotor Time	100	104	100	Adaptive Start Profile-2	100	132	100
Locked Rotor Current	100	105	100	Kickstart Time-2	100	133	100
Motor Service Factor	100	106	100	Kickstart Level-2	100	134	100
Reserved	100	107	100	Jog Torque-2	100	135	100
<b>Motor start/stop</b>				Stop Mode-2	100	136	100
Start Mode	100	108	100	Stop Time-2	100	137	100
Start Ramp Time	100	109	100	Adaptive Stop Profile-2	100	138	100
Initial Current	100	110	100	Adaptive Control Gain-2	100	139	100
Current Limit	100	111	100	Multi Pump-2	100	140	100
Adaptive Start Profile	100	112	100	Start Delay-2	100	141	100
Kickstart Time	100	113	100	DC Brake Torque-2	100	142	100
Kickstart Level	100	114	100	DC Brake Time-2	100	143	100
Jog Torque	100	115	100	Brake Current Limit-2	100	144	100
Stop Mode	100	116	100	Soft Brake Delay-2	100	145	100
Stop Time	100	117	100	<b>Auto-start/stop</b>			
Adaptive Stop Profile	100	118	100	Auto-Start/Stop Mode	100	146	100
Adaptive Control Gain	100	119	100	Run Time	100	147	100
Multi Pump	100	120	100	Stopped Time	100	148	100
Start Delay	100	121	100	Sunday Mode	100	149	100
DC Brake Torque	100	122	100	Sunday Start Time	100	150	100
DC Brake Time	100	123	100	Sunday Stop Time	100	151	100
Brake Current Limit	100	124	100	Monday Mode	100	152	100
Soft Brake Delay	100	125	100	Monday Start Time	100	153	100
<b>Motor start/stop 2</b>				Monday Stop Time	100	154	100
Motor Full Load Current-2	100	126	100	Tuesday Mode	100	155	100

Table 10: Objects with Class, Instance, and Attribute - continued

Object name	Class	Instance	Attribute	Object name	Class	Instance	Attribute
Tuesday Start Time	100	156	100	Starts per Hour	100	186	100
Tuesday Stop Time	100	157	100	Phase Sequence	100	187	100
Wednesday Mode	100	158	100	Auto-Reset Count	100	188	100
Wednesday Start Time	100	159	100	Auto-Reset Delay	100	189	100
Wednesday Stop Time	100	160	100	<b>Protection Actions</b>			
Thursday Mode	100	161	100	Current Imbalance	100	190	100
Thursday Start Time	100	162	100	Undercurrent	100	191	100
Thursday Stop Time	100	163	100	Overcurrent	100	192	100
Friday Mode	100	164	100	Undervoltage	100	193	100
Friday Start Time	100	165	100	Overvoltage	100	194	100
Friday Stop Time	100	166	100	Underpower	100	195	100
Saturday Mode	100	167	100	Overpower	100	196	100
Saturday Start Time	100	168	100	Excess Start Time	100	197	100
Saturday Stop Time	100	169	100	Input A Trip	100	198	100
<b>Protection Levels</b>				Input B Trip	100	199	100
Current Imbalance	100	170	100	<b>Class 101 objects (read/write)</b>			
Current Imbalance Delay	100	171	100	<b>Protection Actions (continued)</b>			
Undercurrent	100	172	100	Network Communications	101	100	100
Undercurrent Delay	100	173	100	Remote LCP Fault	101	101	100
Overcurrent	100	174	100	Frequency	101	102	100
Overcurrent Delay	100	175	100	Phase Sequence	101	103	100
Undervoltage	100	176	100	Motor Overtemperature	101	104	100
Undervoltage Delay	100	177	100	Motor Thermistor Circuit	101	105	100
Overvoltage	100	178	100	Shorted SCR Action	101	106	100
Overvoltage Delay	100	179	100	Battery/Clock	101	107	100
Underpower	100	180	100	<b>Inputs</b>			
Underpower Delay	100	181	100	Input A Function	101	108	100
Overpower	100	182	100	Input A Trip	101	109	100
Overpower Delay	100	183	100	Input A Trip Delay	101	110	100
Excess Start Time	100	184	100	Input A Initial Delay	101	111	100
Restart Delay	100	185	100	Input B Function	101	112	100

Table 11: Objects with Class, Instance, and Attribute - continued

Object name	Class	Instance	Attribute	Object name	Class	Instance	Attribute
Input B Trip	101	113	100	User Parameter 2	101	141	100
Input B Trip Delay	101	114	100	User Parameter 3	101	142	100
Input B Initial Delay	101	115	100	User Parameter 4	101	143	100
Reset/Enable Logic	101	116	100	User Parameter 5	101	144	100
Input A Name	101	117	100	User Parameter 6	101	145	100
Input B Name	101	118	100	<b>Pump Clean</b>			
<b>Relay outputs</b>				Reverse Torque	101	146	100
Relay A Function	101	119	100	Reverse Time	101	147	100
Relay A On Delay	101	120	100	Forward Current Limit	101	148	100
Relay A Off Delay	101	121	100	Forward Time	101	149	100
Relay B Function	101	122	100	Pump Stop Mode	101	150	100
Relay B On Delay	101	123	100	Pump Stop Time	101	151	100
Relay B Off Delay	101	124	100	Pump Clean Cycles	101	152	100
Low Current Flag	101	125	100	<b>Communication card</b>			
High Current Flag	101	126	100	Modbus Address	101	153	100
Motor Temperature Flag	101	127	100	Modbus Baud Rate	101	154	100
Main Contactor Time	101	128	100	Modbus Parity	101	155	100
<b>Analog output</b>				Modbus Timeout	101	156	100
Analog Output A	101	129	100	DeviceNet Address	101	157	100
Analog A Scale	101	130	100	DeviceNet Baud Rate	101	158	100
Analog A Maximum Adjustment	101	131	100	PROFIBUS Address	101	159	100
Analog A Minimum Adjustment	101	132	100	Gateway Address	101	160	100
<b>Display</b>				Gateway Address 2	101	161	100
Language	101	133	100	Gateway Address 3	101	162	100
Temperature Scale	101	134	100	Gateway Address 4	101	163	100
Graph Timebase	101	135	100	IP Address	101	164	100
Graph Maximum Adjustment	101	136	100	IP Address 2	101	165	100
Graph Minimum Adjustment	101	137	100	IP Address 3	101	166	100
Current Calibration	101	138	100	IP Address 4	101	167	100
Adjustment Lock	101	139	100	Subnet Mask	101	168	100
User Parameter 1	101	140	100	Subnet Mask 2	101	169	100



Table 12: Objects with Class, Instance, and Attribute - continued

Object name	Class	Instance	Attribute	Object name	Class	Instance	Attribute
Subnet Mask 3	101	170	100	Bypass Contactor Delay	101	176	100
Subnet Mask 4	101	171	100	Model Rating	101	177	100
DHCP	101	172	100	Screen Timeout	101	178	100
Location ID	101	173	100	Motor Connection	101	179	100
<b>Advanced</b>				External Bypass	101	180	100
Tracking Gain	101	174	100	Shunt Trip Mode	101	181	100
Pedestal Detect	101	175	100	-	-	-	-

## 9 Network Design

### 9.1 Star Topology

In a star network, all controllers and devices connect to a central network switch.

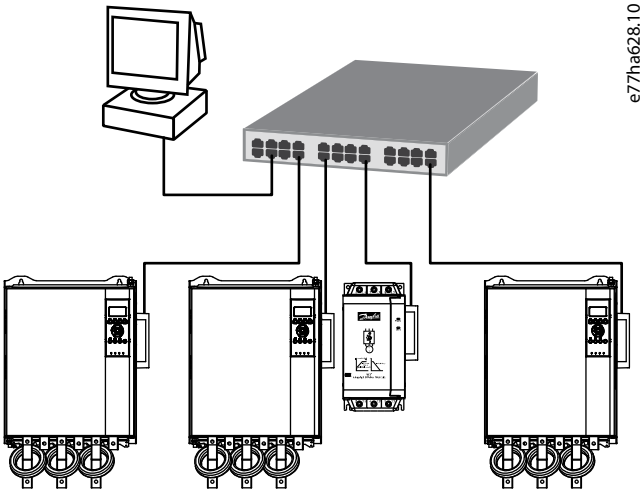

Illustration 2: Example of Star Topology

### 9.2 Line Topology

In a line network, the controller connects directly to 1<sup>st</sup> port of the 1<sup>st</sup> card. The 2<sup>nd</sup> Ethernet port connects to another card, which in turn connects to another device until all devices are connected.

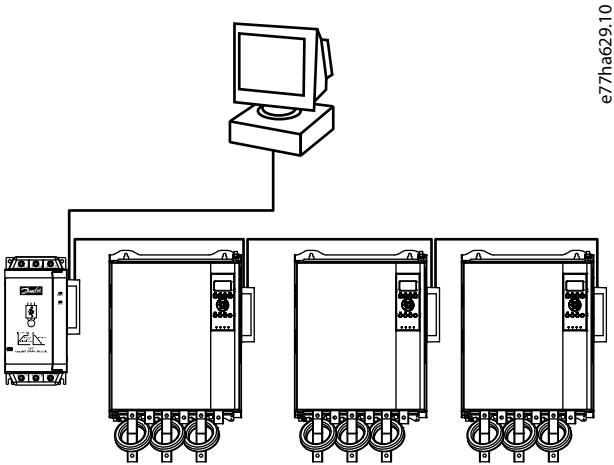

Illustration 3: Example of Line Topology

### NOTICE

The device has an integrated switch to allow data to pass through in line topology. The device must be receiving control power from the soft starter for the switch to operate.

### NOTICE

If the connection between 2 devices is interrupted, the controller cannot communicate with devices after the interruption point.

## NOTICE

Each connection adds a delay to the communication with the next device. The maximum number of devices in a line network is 32. Exceeding this number may reduce the reliability of the network.

### 9.3 Ring Topology

In a ring topology network, the controller connects to the 1<sup>st</sup> card via a network switch. The 2<sup>nd</sup> Ethernet port of the card connects to another device, which in turn connects to another device until all devices are connected. The final device connects back to the switch.

The device supports beacon-based ring node configuration.

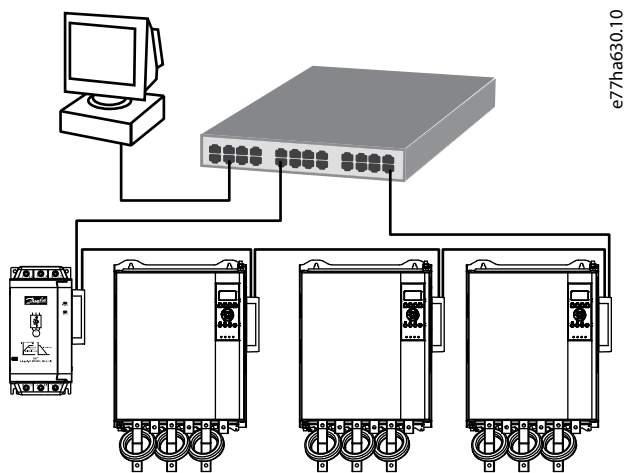

Illustration 4: Example of Ring Topology

## NOTICE

The network switch must support loss of line detection.

### 9.4 Combined Topologies

A single network can include both star and line components.

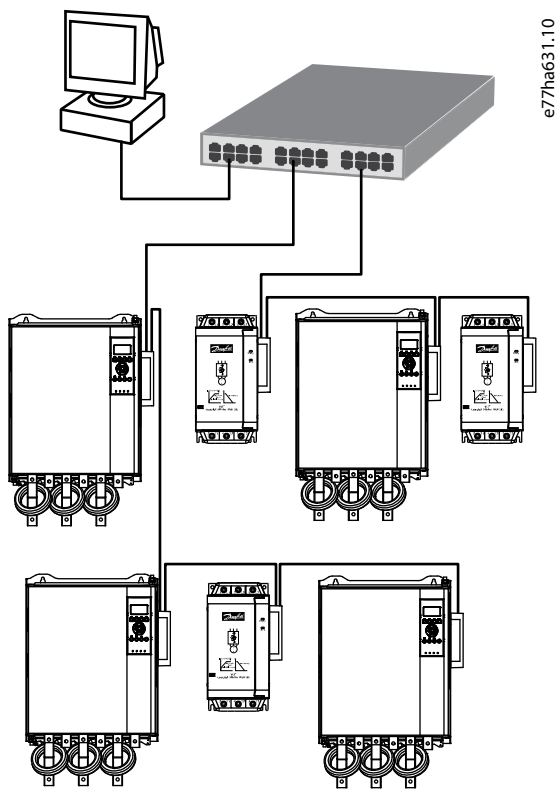

Illustration 5: Example of Combined Topologies

## 10 Specifications

### 10.1 Connections

Soft starter	6-way pin assembly
Contacts	Gold flash
Network	RJ45

### 10.2 Settings

IP address	Automatically assigned, configurable
Device name	Automatically assigned, configurable

### 10.3 Network

Link speed	10 Mbps, 100 Mbps (auto-detect)
Full duplex	
Auto crossover	

### 10.4 Power

Consumption (steady state, maximum)	35 mA@24 V DC
Reverse polarity protected	
Galvanically isolated	

### 10.5 Certification

RCM	IEC 60947-4-2
CE	EN 60947-4-2
ODVA	



Illustration 6: ODVA

**Danfoss A/S**  
Ulsnaes 1  
DK-6300 Graasten  
[vlt-drives.danfoss.com](http://vlt-drives.danfoss.com)

---

Danfoss can accept no responsibility for possible errors in catalogs, brochures and other printed material. Danfoss reserves the right to alter its products without notice. This also applies to products already on order provided that such alterations can be made without subsequential changes being necessary in specifications already agreed. All trademarks in this material are property of the respective companies. Danfoss and the Danfoss logotype are trademarks of Danfoss A/S. All rights reserved.

---

